

Servo Divider

Model DMX

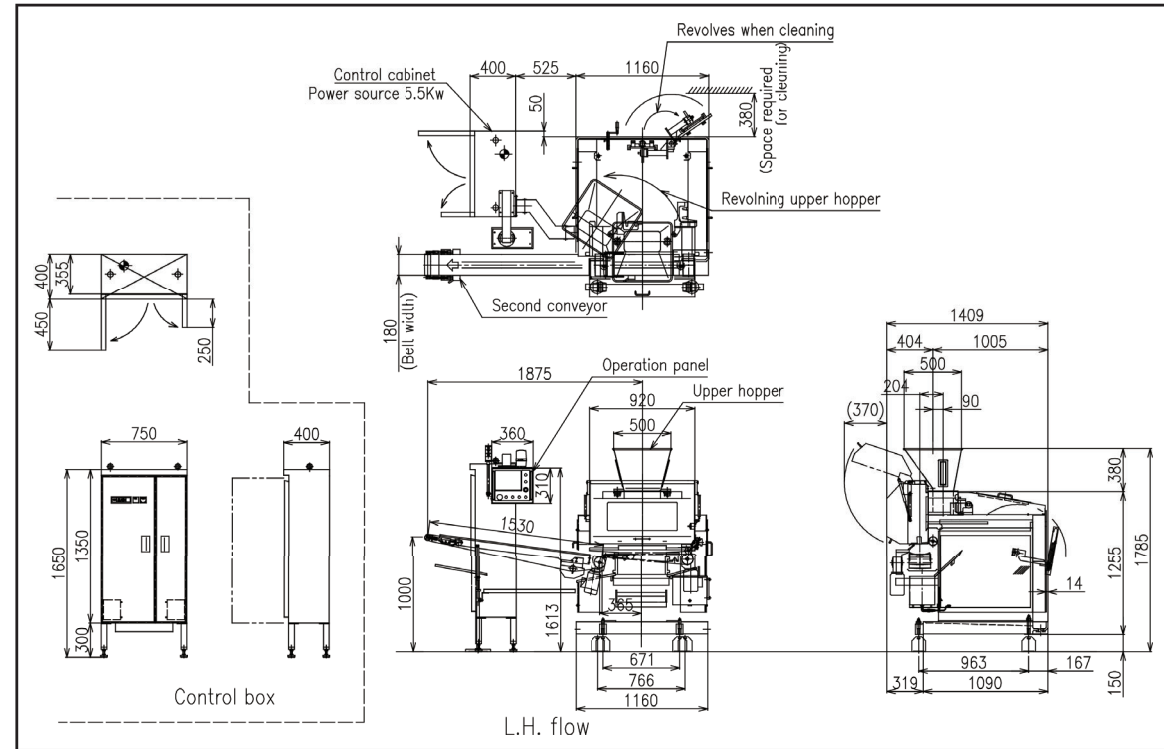

Model DMX specifications

No. of pockets	DMX + No. of pockets				
	3	4	5	6	8
Scaling (g)	80 - 350	40 - 270	30 - 220	25 - 150	20 - 80
Capacity (pcs/h)	900-4500	1200-6000	1500-7500	1800-9000	2400-12000
No. of strokes	5 - 25 st/min				
Power Source	AC200V 3Phases				
Motor (rated)	5.5kW(except rounder)				
Air required	10NL/min(for lubrication)				
Machine weight	Approx. 2300kg				

DMX 3/6		DMX 4/8	
3	6	4	8
80 - 350	25 - 150	80 - 240	20 - 90
900-4500	1800-9000	1200-6000	2400-12000
5 - 25 st/min			
AC200V 3Phases			
5.5kW(except rounder)			
10NL/min(for lubrication)			
Approx. 2300kg			

Note) Specifications and dimensions are subject to change without prior notice.
 Note) Transformer might be needed depending upon the specifications.

SERVO DIVIDER X series

Model DMX for buns & rolls



Precision
 Long life
 Easy cleaning
 Maintenance saving

OSHIKIRI MACHINERY LTD. <https://www.oshikiri.com/>

4, Kiriara-cho, Fujisawa-shi, Kanagawa, 252-0811 Japan
 Phone: 0466-44-6184 Fax: 0466-44-6187 E-mail: intl@oshikiri.com

Oshikiri Corporation of America
 10425 Drummond Road, Philadelphia, Pennsylvania 19154-3898
 Phone: 215-637-6005 Fax: 215-637-6041 E-mail: oshikiri-production@msn.com



OSHIKIRI Website



The Next Generation Divider N series

PRECISION

Pressure feed to dough changeable, divides dough with optimum pressure.
Sucking stroke of main ram and knife changeable.
Independent drives for division head, knife and main ram.
Flexible setting of dividing mode and timing of each component with a basic program in compliance with dough weight and machine speed.
Optional Auto-checker system enables highly precision dividing weight compensation even when batch shifting.

LONG LIFE

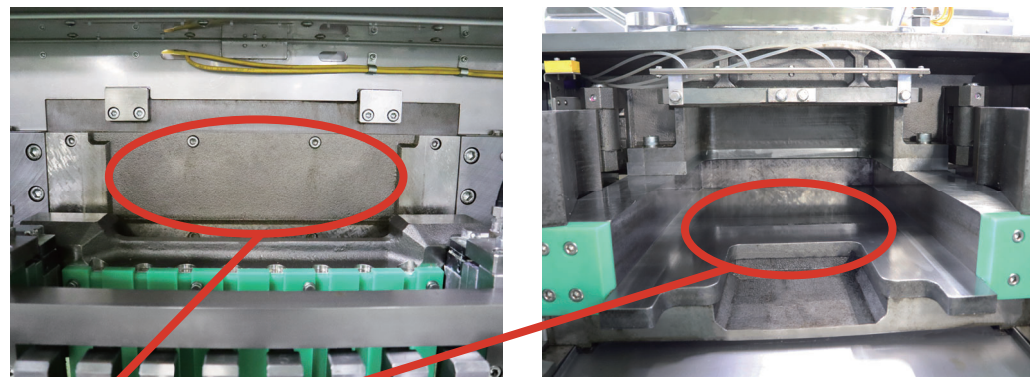

Front & bottom wear strips of dough chamber (i.e. sliding part) are easily replaced.
Division head does not come in contact with sliding parts.
Dough chamber unit is also replaceable.
Oil distributor is able to control oil amount individually.

MAINTENANCE SAVING

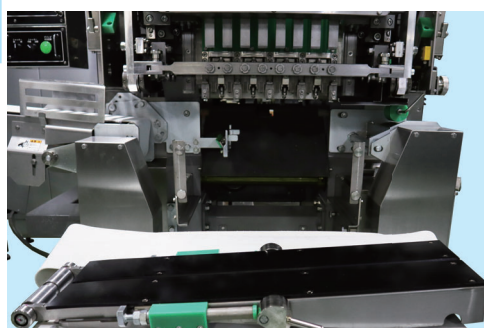

Easily accessible configuration.
One-touch replaceable conveyor belt.
Lubricating points decreased by 50% in comparison with our conventional model.
Touch screen displays a message for lubrication when it is time.

EASY CLEANING

See-through exterior cover.
Components move to cleaning position by one touch on touch screen.

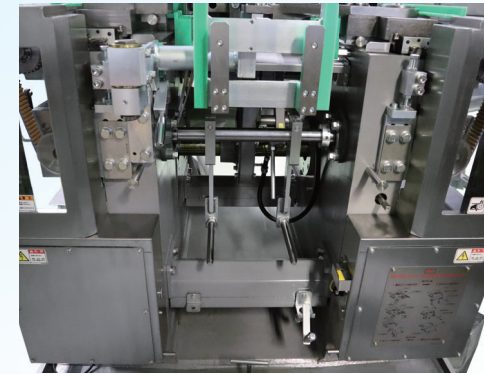

Dough chamber perfectly separated from driving section.
Mechanical units mostly located outside of frame. Easily accessible.

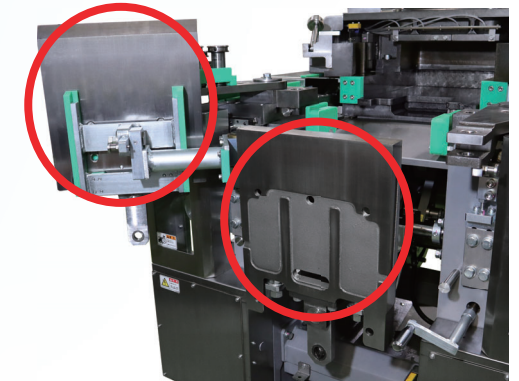

Equipped with cleaning aid device for main ram and knife.
Flip side easily cleaned.

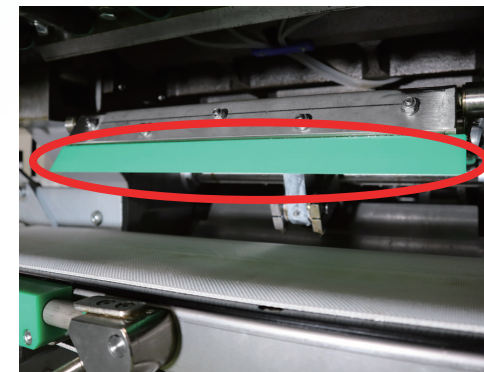

Easy access to flip side of flicker plate.

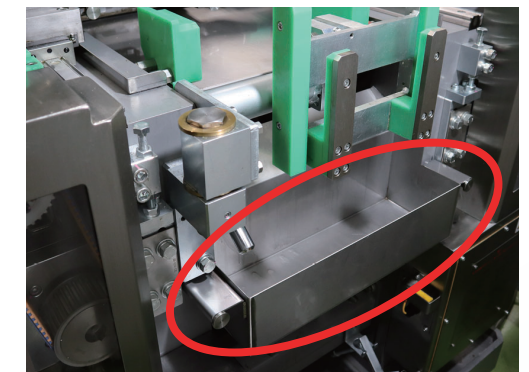

Oil catch pan located in both machine front and rear.

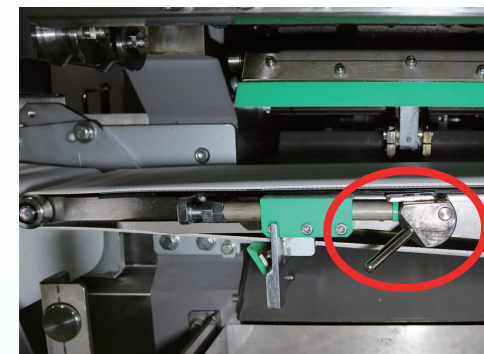

Conveyor belt loosened by one turn of lever.
Even flip side easily cleaned.
All belts made of resin.

